

DT TRUCK 30



DT TRUCK 100

DOTAZIONE STANDARD

Barre paraciclisti
Cesto - Alluminio 1800x700x1100 mm, portata max 225 kg
Comando avvio/arresto motore dal cesto
Comando dal cesto per segnalatore acustico
Connessione elettrica 230V nel cesto
Contaore
Controllo anticollisione tra bracci e cabina del veicolo
Dispositivo di stabilizzazione automatica
Impianto idraulico a filtraggio differenziato con filtri ad alta efficienza
Livella multiassiale
Luci intermittenti sugli stabilizzatori
Operatività completamente elettronica
Pompa di emergenza manuale
Rotazione cesto $\pm 90^\circ$
Rotazione torretta 1440°
Schermo CAN-bus 3.5" in cabina
Sistema di controllo via CAN-bus
Teleassistenza remota in tempo reale (CRSS)
Traverse anteriori e posteriori estensibili idraulicamente
Valvole di blocco flangiate sui cilindri
Verniciatura - Braccio telescopico: Blu RAL 5013 o Bianco RAL 9010
Verniciatura - Cilindri, parte aerea e pistoni: Bianco RAL 9010
Verniciatura - Telaio: Blu RAL 5013 o Nero

STANDARD EQUIPMENT

Anti cyclist protection bars
Cage – Aluminium 5'11"x2'4"x3'7", max load 496 lbs
Start/Stop engine from the cage
Acoustic warning from the cage
230V electric connection in the cage
Hour counter
Boom and truck cabin anti-collision device
Automatic stabilization device
Fully compensated hydraulic system with high pressure filtering system
Multi-axial level
Blinking lights on outriggers
Fully electronically operated
Emergency hand pump
Cage rotation $\pm 90^\circ$
Turret rotation 1440°
Display CAN-bus 3.5" on the cab
CAN-bus control system
Remote management and diagnostic software (CRSS)
Rear and front stabilizing beams with automatic hydraulic extension
Flanged lock valves on cylinders
Painting - Telescopic booms: Blue RAL 5013 or White RAL 9010
Painting - Cylinders, turret and pistons: White RAL 9010
Painting - Mainframe: Blue RAL 5013 or Black



ACCESSORI DISPONIBILI

Anemometro
Argano elettrico, portata massima 200 kg
Camion con guida a destra
Camion diverso da veicolo standard
Cassetta degli attrezzi
Carica batteria per autocarri
Cesto - Vetroresina 800x600x1100 mm, portata massima 120 kg
Cesto - Vetroresina 1200x620x1100 mm, portata massima 200 kg
Cesto - Carico materiali con sponde abbattibili 1400x700x550/2430x1166x50 mm, portata massima 205 kg
Comandi di stabilizzazione dal cesto
Connessione aria/acqua tra cesto e torretta, pressione max 225 bar
Dispositivo anti-collisione a protezione del cesto con tecnologia sonar
Dispositivo di chiusura automatica
Doppia postazione di stabilizzazione a terra (8 tasti)
Elettropompa monofase con caricabatteria tampone
Filocomando a terra da 5 m
Gancio di sollevamento, portata massima 260 kg completo di certificazione gru
Imbracatura di sicurezza
Impianto interfonico fisso terra/cesto
Interruttore magnetotermico di protezione sulla linea elettrica
Linea cesto con spine/prese 110V (extra USA)
Luci ingombro posteriori
Pedale uomo morto al cesto (extra USA)
Pedale uomo morto al cesto e pulsante uomo morto ai controlli a terra
Piastre di appoggio a terra con relativo porta piastre
Radiatore olio idraulico
Radiocomando
Radiocomando nel cesto + postazione fissa a terra
Rotolampada magnetica
Software per la gestione della macchina da remoto
Spazzole anti detriti nei bracci
Spondine
Stabilizzatori maggiorati (750 mm) con piastre in legno
Verniciatura speciale - Telaio
Verniciatura speciale - Parte aerea, cilindri e stabilizzatori

STANDARD COMPLIANCE

ANSI 92.20
UNI EN 280
CSA B354.6
CE
Crane certification (EN 12999 standard certified)

OPTIONS & ACCESSORIES

Anemometer
Electric winch, max load 441 lbs
Right hand drive truck
Mounting on different truck
Tool box
Truck battery charger
Cage - Fiberglass 2'7"x2'x3'7", max load 264 lbs
Cage - Fiberglass 3'11"x2'x3'7", max load 441 lbs
Cage - Material handling with collapsible sides 4'7"x2'4"x1'10"/7'12"x3'10"x1'8", max load 452 lbs
Stabilization controls from the cage
Air/Water connection between cage and turret, max pressure 225 bar
Ultrasonic anti-trap cage protection device
One-click auto-closing function
Double stabilization station on the ground (8 keys)
Mono-phase electro pump with its buffer battery charger
16' length wired controller, control at ground
Hoist Hook, max load 573 lbs crane certification included
Safety harness
Fixed intercom ground/cage
Circuit breaker in the cage
Basket line with 110V plugs/sockets (extra USA)
Rear clearance lights
Dead man pedal in the cage (extra USA)
Dead man pedal in the cage and dead man switch on ground controls
Outrigger pads along with corresponding pad holder
Hydraulic oil cooler
All function radio control
Radio control on the cage + fixed control station at ground
Magnetic xenon beacon
Remote management software
Anti-debris brushes on booms
Aluminium side walls
Extended stroke outriggers with wooden pads
Special painting - Mainframe
Special painting - Upper part, cylinders and outriggers

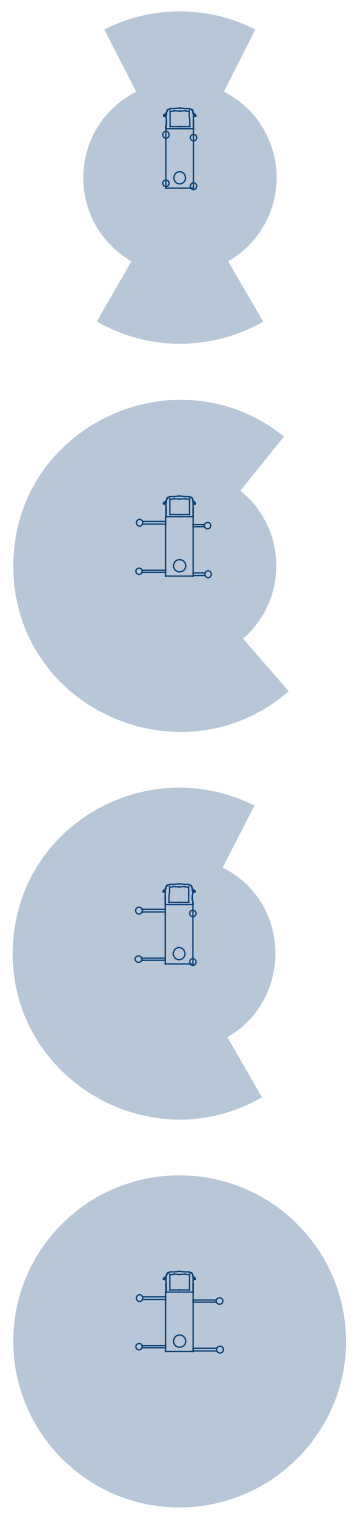
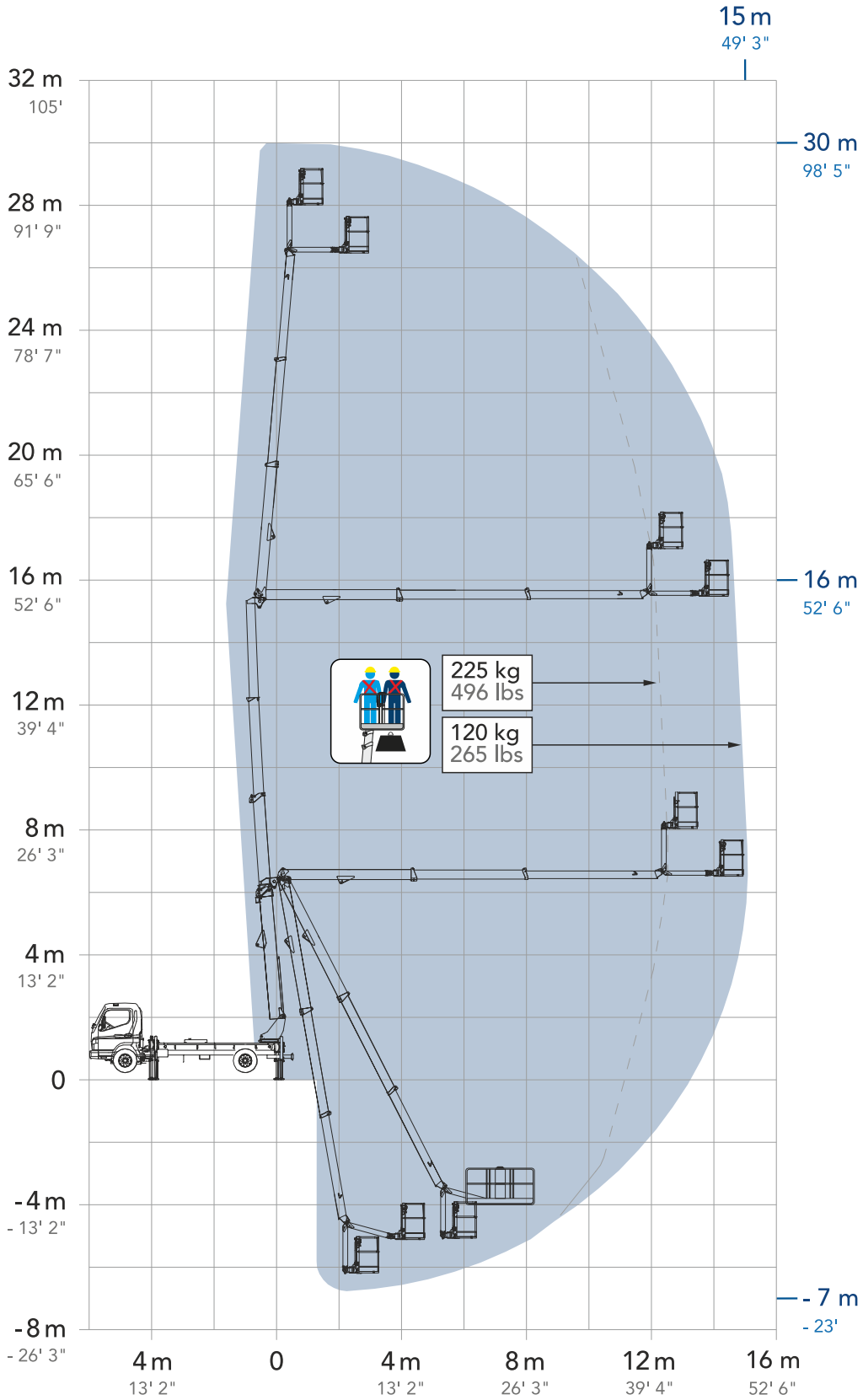

depending on chassis

DIMENSIONI

A	Lunghezza cesto	1800 mm
B	Profondità cesto	700 mm
C	Altezza della macchina	2360 mm
D	Lunghezza della piattaforma	7130 mm
E	Lunghezza totale	7640 mm
F	Larghezza della macchina	2200 mm
G₁	Estensione parziale stabilizzatore	200 mm
G	Estensione totale stabilizzatore	800 mm

* le misure variano in base al telaio

DIMENSIONS

Cage length	5 ft 11 in
Cage width	2 ft 4 in
Height	7 ft 9 in
Platform length	23 ft 4 in
Overall length	25 ft
Width	7 ft 3 in
Partial stabilizer extension	8 in
Full stabilizer extension	2 ft 7 in

* measurements depend on chassis

PRESTAZIONI

Altezza di lavoro	30 m
Sbraccio laterale	15 m
Punto di scavalco	16 m
Lavoro negativo	- 7 m
PTT minimo	6,5 T

PERFORMANCE

Working height	100 ft
Horizontal outreach	49 ft 3 in
Up and over clearance	52 ft 6 in
Negative work (below ground level)	- 23 ft
Minimum GVW	14330 lbs



30 m
100 ft

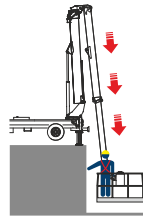

-7 m
-23 ft

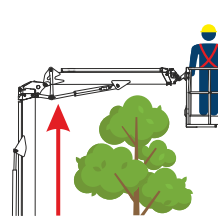

16 m
52 ft 6 in

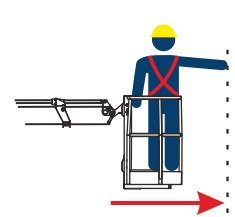

15 m
49 ft 3 ft

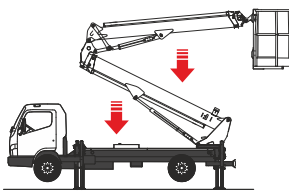

AUTO

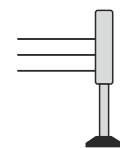
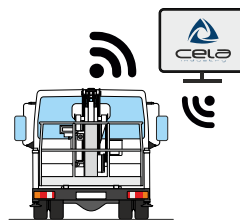
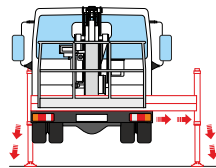

H+H

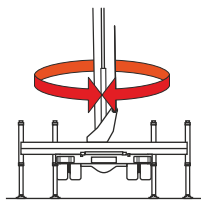

1440°

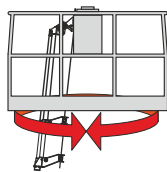

90°+90°

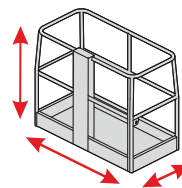

ALUMINIUM
1,8X0,7X1,1
5'11"X2'4"X3'7"



ELECTRONIC

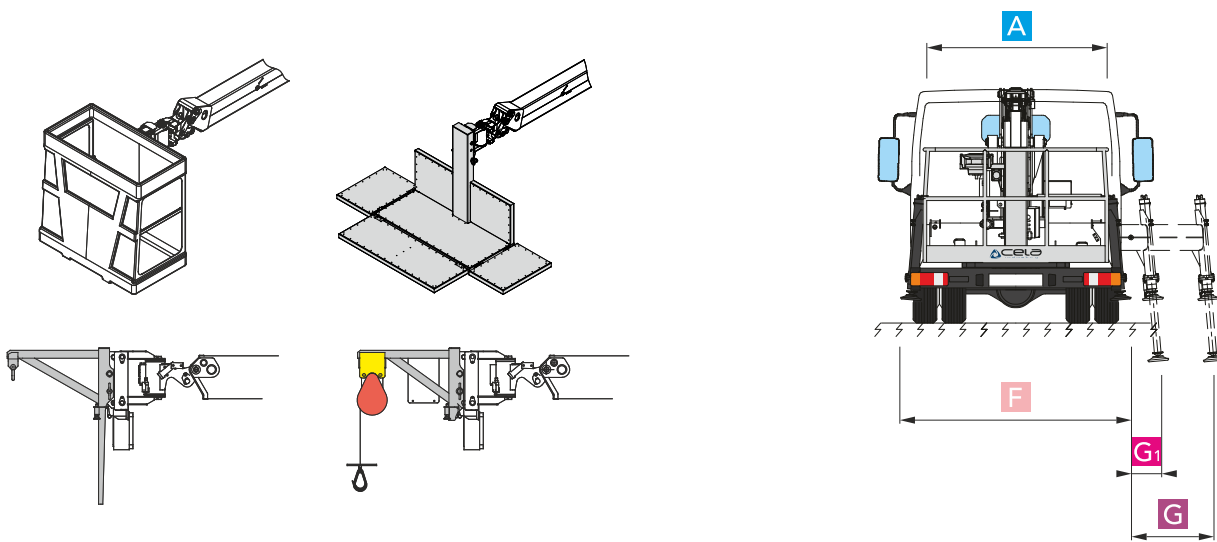
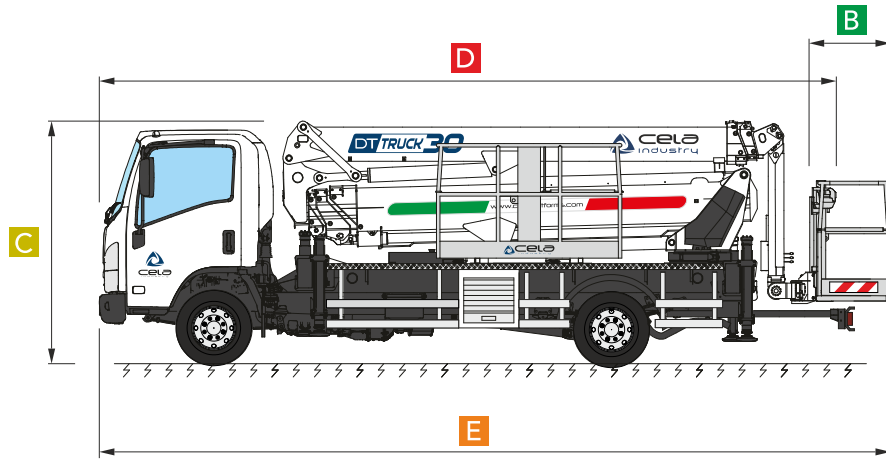

Come un ascensore
Like an elevator

Sbarco in quota autorizzato
Authorized height landing

Tutto in uno
All in one

Ti spianiamo la strada
We level the road for you

Siamo i più forti
We are the strongest ones

225 KG
496 lbs

260 KG
573 lbs